

LAVATORY CARRIER



Approval
Date

Customer
Approval

Job
Location

Job
Name

Dimensional Data (Inches/mm) are Subject to Manufacturers Tolerance and Change Without Notice. Wade Division / Tyler Pipe Assumes No Responsibility For Superseded or Voided Data

420-M29

HANGER PLATE CARRIER WITH PIPE UPRIGHTS,
WELDED BASE FEET & HARDWARE.

FIXTURE

Manufacturer Kohler

Name Memoirs No. K-2268

Style Lavatory

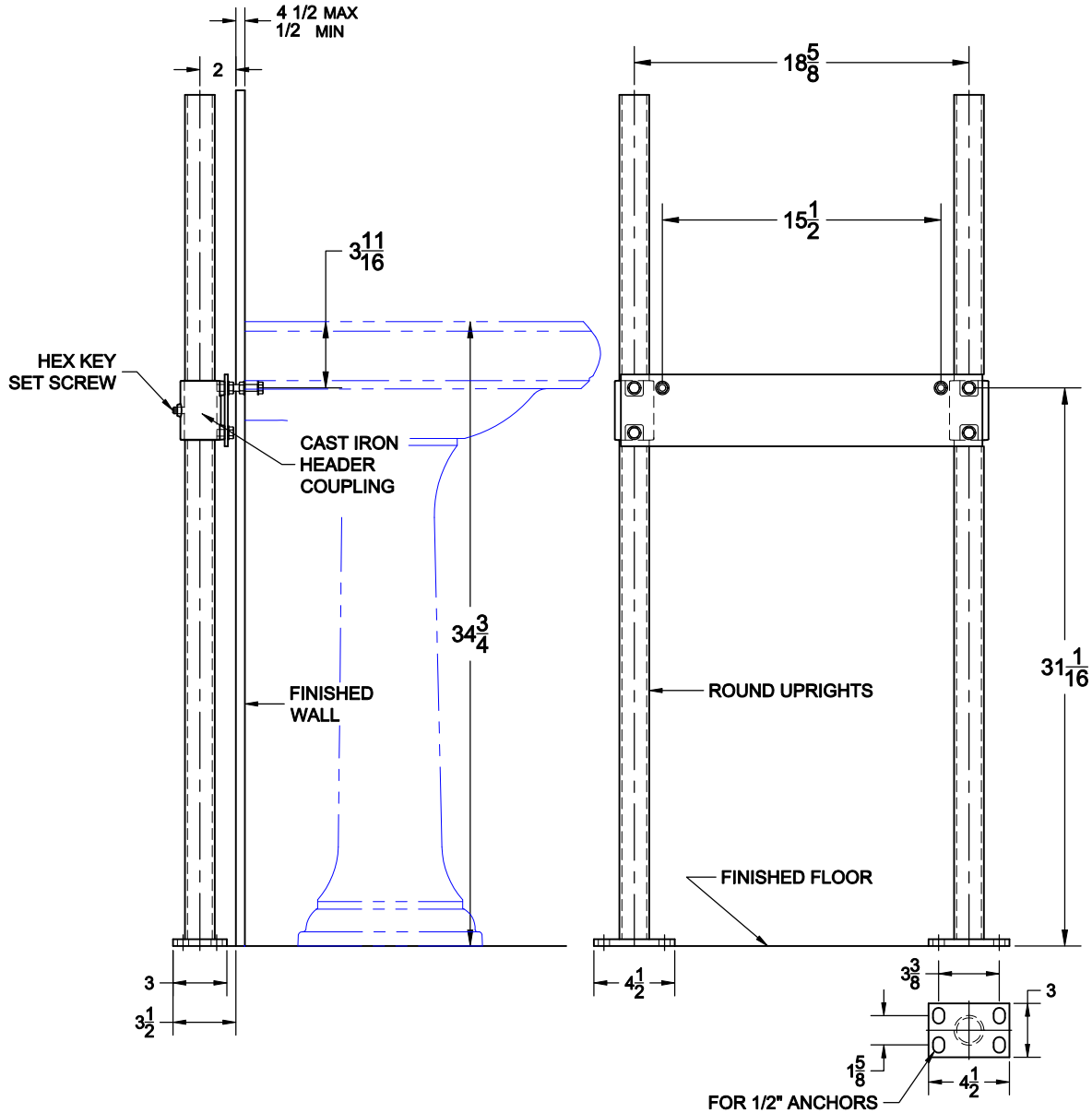

OPTIONS

Cat. No.	Type	Wt. Lbs.	Suffix	Description
<input type="checkbox"/> 420-M29	SGL	30.0	<input type="checkbox"/> M36	SQUARE UPRIGHTS

NOTE: CONTRACTOR MUST VERIFY DIMENSIONS WITH FIXTURE MANUFACTURER ROUGH-IN DATA
TYLER PIPE / WADE DIVISION ACCEPTS NO RESPONSIBILITY FOR ANY INACCURACIES IN DRAWING

AutoCad.dwg